

*Williams*®   
ELECTRONICS GAMES, INC.

JULY 1993  
16-50017-103

# *INDIANAJONES*

## Operators Handbook

WILLIAMS ELECTRONICS GAMES, INC.  
3401 N. CALIFORNIA AVE.  
CHICAGO, IL 60618

## TABLE OF CONTENTS

RUBBER RINGS.....	1
RAMPS.....	2
LOWER PLAYFIELD PARTS.....	3
UPPER PLAYFIELD PARTS.....	4
UPPER PLAYFIELD PARTS LOCATIONS.....	5
SOLENOID TABLE.....	6
SOLENOID LOCATIONS.....	7
LAMP MATRIX.....	8
LAMP LOCATIONS.....	9
SWITCH MATRIX.....	10
SWITCH LOCATIONS.....	11
MAIN MENU.....	12
FUSE LIST.....	13

# RUBBER PARTS

Item	Part No.	Qty	Description
A	23-6300	16	5/16" Rubber Rings
B	23-6535	1	Bumper
C	23-6556	10	Black Sleeve Bumpers
D	23-6552	2	Yellow Sleeve Bumpers
E	23-6308	1	3-1/2" Rubber Ring
F	23-6306	2	2-1/2" Rubber Rings
G	23-6301	5	3/4" Rubber Rings
H	23-6303	1	1-1/4" Rubber Ring
I	23-6599	2	7/16" Rubber Rings
J	23-6695	2	Black Flipper Rings

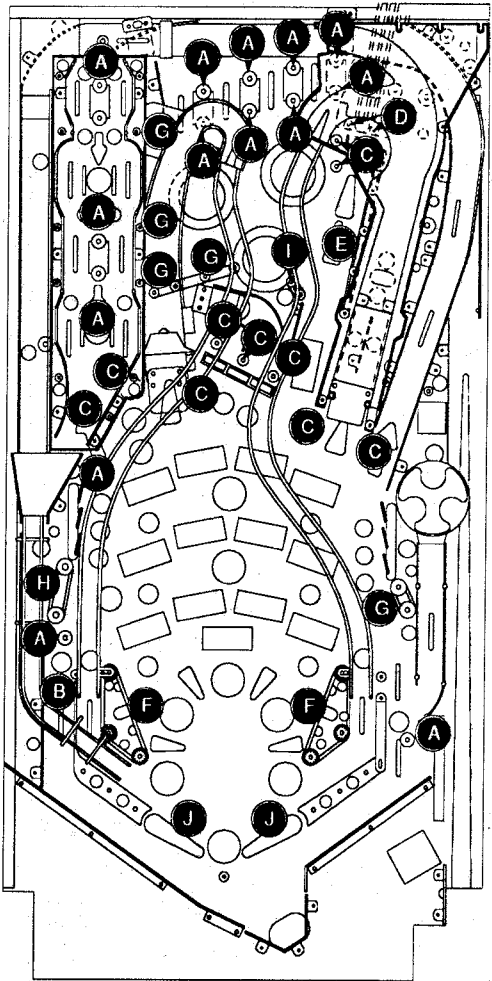

# RAMPS

Item	Part Number	Description
1.	<b>A-16319</b>	<b>Rt. Plastic Ramp Assembly</b>
a)	5647-12693-21	Sub-miniature Switch
b)	01-11665	Mounting Bracket-Fighter Plane
c)	A-16707	Fighter Plane
d)	A-16909	Photo Transistor Assy.,-RTV
e)	A-16908	LED Assembly, RTV
2.	<b>A-16706</b>	<b>Metal Ramp Assembly</b>
a)	A-16824	Jackpot Light Assembly
b)	A-16909	Photo Transistor Assy., RTV
c)	A-16908	LED Assembly, RTV
d)	5647-12693-21	Sub-miniature Switch
3.	12-7069	Wire Ramp - Left
4.	12-7070	Wire Ramp - Right
5.	12-7080	Wire Ramp - Bottom
6.	A-16863	Bridge Ramp Assembly
7.	01-11541	Straight Metal Ramp

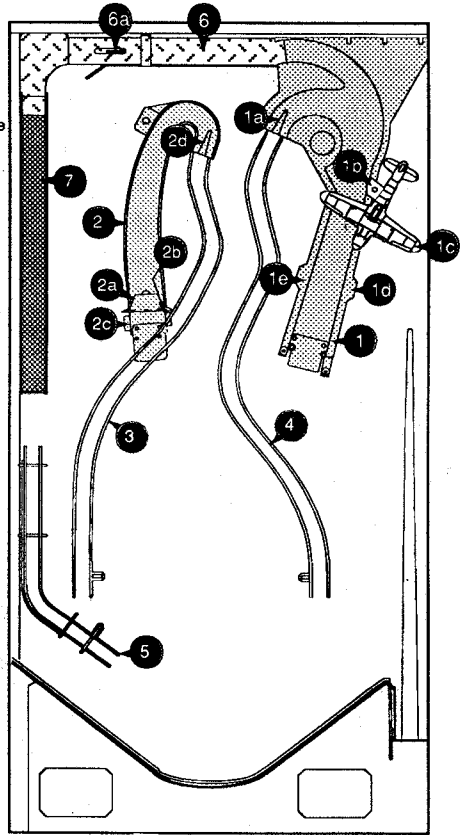

# LOWER PLAYFIELD PARTS LOCATIONS

**Item**   **Part Number**   **Description**

- 1. A-15205-R-2 Lower Right Flipper Assembly
- 2. 01-11781 Support Bracket (2 Used)
- 3. A-16765 Outhole Ball Trough Assembly
- 4. B-12665 Kicker Arm (Slingshot) Assy., Right
- a) A-14369-R Coil & Bracket Assembly
- b) 10-128 Spring
- c) B-8284-1 Kicker Switch Assembly
- 5. A-15340 Motor EMI Board
- 6. A-16226 Rotor Lock Door Unit Assy.
- 7. A-16228 Rotor Lock Unit assembly
- 8. A-16231 Rotor Ball Popper Assembly
- 9. A-16317 Ball Trough Assembly
- 10. A-16637-2 Plfld. Slide Mechanism, Right
- 11. A-16301 Diverter Assembly
- 12. A-14615 1-Bank Drop Target Assembly
- 13. A-14522 Actuator Assembly (2 Used)
- 14. A-16739 4-Lamp PC Board
- 15. A-9415-2 Jet Bumper Coil Assembly
- 16. B-12030-2 Switch & Diode Assembly (3 Used)
- 17. 01-10726 Rear Guide Leg (2 Used)
- 18. A-15946 Bridge Driver PC Board
- 19. A-16637-1 Plfld. Slide Mechanism, Left
- 20. A-15430 10-Switch Opto Assembly
- 21. A-16929-1 3-Bank Drop Target Assembly
- 22. A-17073 Ball Eject Assembly
- 23. A-16716-2 38-Lamp Combo Assembly
- 24. B-12665 Kicker Arm (Slingshot) Assy., Left
- a) A-14369-L Coil & Bracket Assembly
- b) 10-128 Spring
- c) B-8284-1 Kicker Switch Assembly
- 25. A-16823 3-Lamp Board (2 Used)
- 26. A-15205-L-2 Lower Left Playfield Assembly
- 27. B-12224 Single Lamp Board
- 28. A-13901-2 Opto Ramp Switch Board

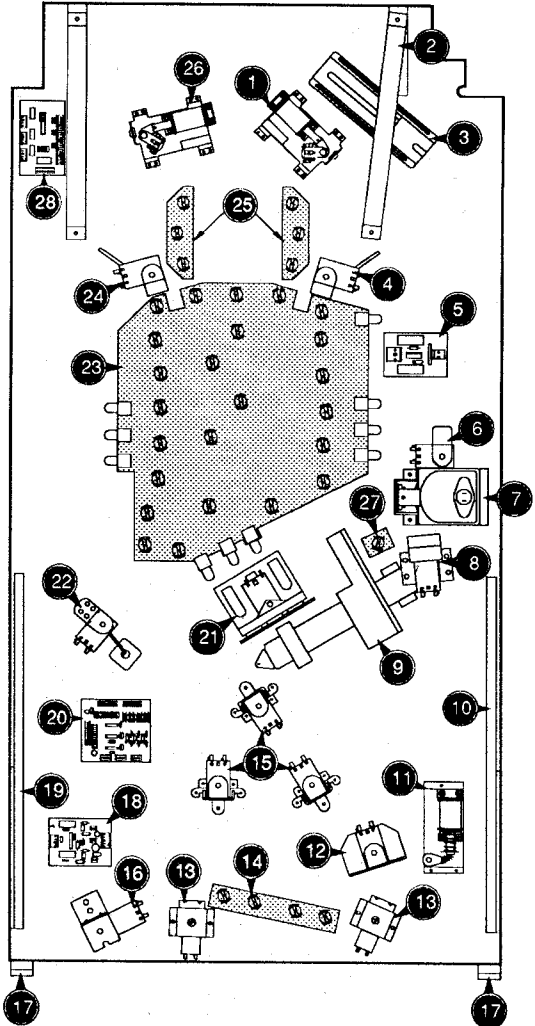

*Underside of Playfield, Viewed In Raised Position*

# UPPER PLAYFIELD PARTS LOCATIONS

<u>Item</u>	<u>Part Number</u>	<u>Description</u>	<u>Item</u>	<u>Part Number</u>	<u>Description</u>
1	A-14525	Shooter	40	A-15205-L-2	Flipper Assembly
2	A-16765	Ball Trough	40a)	20-9250-5	Flipper Paddle & Shaft
3	A-15205-R-2	Flipper Assembly	41	A-9415-2	Jet Bumper Assembly
3a)	20-9250-5	Flipper Paddle & Shaft	42	A-17073	Ball Eject Assembly
4	A-16911-1	Flipper Ball Guide	42a)	A-9381-L	Micro Switch Eject Assembly
5	A-16918	Ball Gate Assembly	43	A-16710	Right Ruins
6	A-14369-R	Right Slingshot	44	A-13204-50017	Bottom Arch Assembly
6a)	B-12665	Nylon Kicker			
7	12-6466-6	Wire Guide			
8	A-16641	Ball Guide			
9	12-7070	Wire Ramp-Right			
10	A-16418	Standup Target			
11	A-16228	Rotor Lock Unit			
11a)	14-7982	Motor			
11b)	A-16225	Opto Interrupter Plate			
11c)	A-16226	Rotor Lock Door Unit			
11d)	A-16227	Rotor Lock Opto Assembly			
11e)	A-16708	Idol Assembly			
12	A-16231	Ball Popper			
13	01-11533	Right Ramp Guard			
14	01-11534	Left Ramp Guard			
15	A-16707	Plane			
16	A-14615	Single Drop Target			
17	A-16654	Opto Plate Assembly			
18	A-16302	Diverter Ball Guide			
19	A-16301	Diverter Assembly			
19a)	A-16636	Diverter Plunger			
19b)	A-14185	Drive Arm Assembly			
20	A-16319	Right Ramp Assembly			
21	A-16418	Captive Ball Wireform			
22	A-16596-2	Ball Gate Assembly			
22a)	A-14422	Coil & Bracket Assembly			
23	A-16863	Metal Bridge Ramp			
24	A-16596-1	Ball Gate Assembly			
24a)	A-14422	Coil & Bracket Assembly			
25	A-16738	Motor Drive Unit			
25a)	A-16657	Motor Opto Switch Assembly			
26	A-16656	Up/Down Post Assembly			
27	A-16706	Metal Ramp			
28	A-17168	Mini Playfield Assembly			
28a)	12-6466-5	Wire Guide 1-1/4			
28b)	12-6466-2	Wire Guide 1/2			
28c)	A-16735	Pivot Bracket/Shaft Assembly			
29	A-16709	Bi-Plane Assembly			
30	A-16824	Jackpot Light Assembly			
31	A-16816-4	Oblong Standup Target			
32	01-11541	Straight Metal Ramp			
33	01-11542	Metal Chute			
34	A-16032-2	3-bank Drop Target			
35	12-7080	Wire Ramp-Bottom			
36	12-7069	Wire Ramp-Left			
37	12-6466-1	Wire Guide			
38	A-14369-L	Left Slingshot			
39	A-16911-2	Flipper Ball Guide			

**Parts Under Bottom Arch**

<u>Part Number</u>	<u>Description</u>
31-1008-50017	Screened Bottom Arch
12-7090	Wire Fence
20-9041	Tinnerman Speednut
20-9601	#8-32 Nut Retainer

**Not Shown**

<u>Part Number</u>	<u>Description</u>
A-16765	Ball Trough Assembly Complete
03-8929-1	*Full Playfield Mylar
16-50017-1	Instruction Card
20-6500	Steel Ball

**\*The INDIANA JONES hardcoat playfield does not require a full mylar. However Mylars can be purchased through your local Williams Distributor.**

# UPPER PLAYFIELD PARTS LOCATIONS

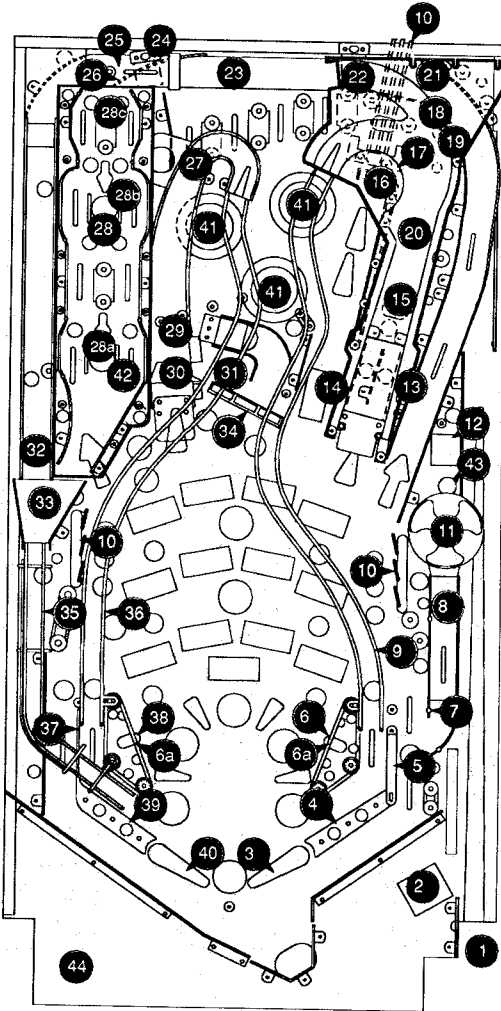

# SOLENOID TABLE

Sol. No.	Function	Solenoid Type	Voltage Connections			Drive Wire	Drive Connections			Drive Wire Color	Solenoid Part Number Flashlamp Type	
			Playfield	Backbox	Cabinet		Playfield	Backbox	Cabinet		Playfield	Backbox
01	Ball Popper	High Power	J107-3			Q82	J130-1			Vio-Brn	AE-26-1200	
02	Ball Launch	High Power	J107-3			Q80	J130-2			Vio-Red	AE-23-800	
03	Totem Drop Lip	High Power	J107-3			Q78	J130-4			Vio-Orq	AE-26-1200	
04	Ball Release	High Power	J107-3			Q76	J130-5			Vio-Yel	AE-26-1500	
05	Center Drop Bank	High Power	J107-3			Q64	J130-6			Vio-Grn	AE-26-1200	
06	Idle Release	High Power	J107-3			Q66	J130-7			Vio-Blu	AE-26-1500	
07	Knocker	High Power	J107-3			Q68	J130-8			Vio-Blk	AE-23-800	
08	Left Eject	High Power	J107-3			Q70	J130-9			Vio-Gry	AE-26-1200	
09	Left Jet Bumper	Low Power	J107-2			Q58	J127-1			Brn-Blk	AE-26-1200	
10	Right Jet Bumper	Low Power	J107-2			Q56	J127-3			Brn-Red	AE-26-1200	
11	Bumper Bas	Low Power	J107-2			Q54	J127-4			Brn-Orq	AE-26-1200	
12	Left Slingshot	Low Power	J107-2			Q52	J127-5			Brn-Yel	AE-27-1200	
13	Right Slingshot	Low Power	J107-2			Q50	J127-6			Brn-Grn	AE-27-1200	
14	Left Control Gate	Low Power	J107-2			Q48	J127-7			Brn-Blu	A-14405	
15	Right Control Gate	Low Power	J107-2			Q46	J127-8			Brn-Vio	A-14406	
16	Totem Drop Down	Low Power	J107-2			Q44	J127-9			Brn-Gry	SM1-26-600	
17	Eterna Life	Flasher	J107-6	J106-5		Q42	J126-1	J125-1		Bk-Brn	#906(1)	#906(3)
18	Light Jackpot	Flasher	J107-6	J106-5		Q40	J126-2			Bk-Red	#906(1)	
19	Super Jackpot	Flasher	J107-6	J106-5		Q38	J126-3			Bk-Orq	#89(1)	
20	Knackpot	Flasher	J107-6	J106-5		Q36	J126-4	J125-5		Bk-Yel	#89(1)	#906(2)
21	Path Of Adventure	Flasher	J107-6	J106-5		Q28	J126-5	J125-6		Blu-Grn	#89(1)	#906(4)
22	Mini Motor Left	Low Power	J118-2			Q30	J126-6			Blu-Bk		
23	Mini Motor Right	Low Power	J118-2			Q34	J126-7			Blu-Vio	14-7988	
24	Plane Gun LEDs	Flasher	J118-2	J106-5		Q32	J126-8	J125-9		Blu-Gry	A-16854	
25	Doofight Hurry Up	Gen. Purpose	J107-6			Q26	J122-1			Blu-Brn	#89(1)	
26	Right Ramp	Gen. Purpose	J107-6	J106-5		Q24	J122-2	J124-2		Blu-Red	#89(3)	#906(1)
27	Left Ramp	Gen. Purpose	J107-6	J106-5		Q22	J122-3	J124-3		Blu-Orq	#89(1)	#906(1)
28	Subway Release	Gen. Purpose	J107-1			Q20	J122-4			Blu-Yel	AE-26-1500	
29-36	<i>See Flipper Circuits</i>											
37	Left Side Flasher	Low Power	J107-6	J106-5		Q18	J4-2	J4-2		Brn-Wht	#89(2)	#906(1)
38	Right Side Flasher	Low Power	J107-6	J106-5		Q16	J4-4	J4-4		Bk-Wht	#89(2)	#906(1)
39	Special Flasher	Low Power	J107-6			Q14	J4-5			Org-Wht	#89(2)	
40	Totem Multiball	Low Power	J107-6			Q13	J4-6			Yel-Wht	#89(1)	
41	Jackpot Multiplier Fl.	Low Power	J107-6			Q9	J3-2			Grn-Wht	#89(1)	
42	Wheel Motor	Low Power	J118-2			Q10	J3-3			Blu-Wht	14-7982	
<b>*Note: Controlled from the B-Driver Board, not the Power Driver Board</b>												
<b>General Illumination</b>												
01	Top Playfield	G.I.	J121-1			Q18	J121-7			Wht-Brn	#44	
02	Bottom Playfield	G.I.	J121-2			Q10	J121-8			Wht-Orq	#44	
03	Insert Top	G.I.		J120-3		Q14		J120-9		Wht-Yel		#555
04	Insert Bottom	G.I.		J120-4		Q16		J120-10		Wht-Grn		#555
05	Return Lane/Coin	G.I.	J121-6		J119-3	Q12	J121-11		J119-1	Wht-Vio	#44	
<b>Flipper Circuits</b>												
			Voltage Connections		Drive Transistors	Drive Connections		Drive Wire Colors	Coil Part Number	Coil Colors		
(29)	(30)		Playfield	Hold	Power	Playfield	Hold	Power	Hold			
	Lower Right Flipper	Lwr. Rt. Power	J907-7 (Blu-Yel)	Q4		J902-13		Blu-Vio		FL-11629	Blue	
		Lwr. Rt. Hold	J907-7 (Blu-Yel)		Q11	J902-11			Org-Grn			
(31)		Lwr. Lt. Power	J907-9 (Gry-Yel)	Q3		J902-9		Blu-Gry		FL-11629	Blue	
(32)	Lower Left Flipper	Lwr. Lt. Hold	J907-9 (Gry-Yel)		Q9	J902-7			Org-Blu			
33	Diverter Power	Up Rt. Power	J907-1 (Blu-Yel)	Q2		J902-6		Bk-Yel		FL-11753-	Brown	
34	Diverter Hold	Up Rt. Hold	J907-1 (Blu-Yel)		Q7	J902-4			Org-Vio			
35	Top Lockup Power	Up Lt. Power	J907-4 (Gry-Yel)	Q1		J902-3		Bk-Blu		A-15943	Brown	
36	Top Lockup Hold	Up Lt. Hold	J907-4 (Gry-Yel)		Q5	J902-1			Org-Gry			



# SOLENOID LOCATIONS

Item No.	Coil/Flasher No.	Assy No.	Description
01	AE-26-1200	A-16231	Ball Popper
02	AE-23-800	A-14525	Ball Launch
03	AE-26-1200	A-14615	Totem Drop Up
04	AE-26-1500	A-16765	Ball Release
05	AE-26-1200	A-16032-2	Center Drop Bank
06	AE-26-1500	A-16226	Idol Release
07	AE-23-800	B-10686-1	Knocker
08	AE-26-1200	A-17073	Left Eject
09	AE-26-1200	A-9415-2	Left Jet Bumper
10	AE-26-1200	A-9415-2	Right Jet Bumper
11	AE-26-1200	A-9415-2	Bumpeur Bas
12	AE-27-1200	A-14369-L	Left Slingshot
13	AE-27-1200	A-14369-R	Right Slingshot
14	A-14406	A-14422	Left Control Gate
15	A-14406	A-14422	Right Control Gate
16	SM1-26-600	A-14615	Totem Drop Down
17	24-8802	A-12336-1	Eternal Life #906
	24-8802	-----	Backbox #906
18	24-8802	A-16824	Light Jackpot #906
19	24-8704	A-9302	Super Jackpot #89
20	24-8704	A-8798	Jackpot #89
	24-8802	-----	Backbox #906
21	24-8704	A-8798	Path Of Adventure #89
	24-8802	-----	Backbox #906
22	14-7988	A-16738	Mini Motor Left
23	14-7988	A-16738	Mini Motor Right
24	-----	A-16834	Plane Gun LEDs
	24-8802	-----	Backbox #906
25	24-8704	A-9359	Dogfight Hurry Up #89
26	24-8704	A-8798/A-16861	Right Ramp #89
	24-8802	-----	Backbox #906
27	24-8704	A-16861	Left Ramp #89
	24-8802	-----	Backbox #906
28	AE-26-1500	A-16317	Subway Release
<i>29 to 36 see Flipper Circuits</i>			
37	24-8704	A-8798	Left Side Flasher #89
	24-8802	-----	Backbox #906
38	24-8704	A-8798	Right Side Flasher #89
	24-8802	-----	Backbox #906
39	24-8704	A-9302	Special Flashers #89
40	24-8704	A-9302	Totem Flasher #89
41	24-8704	A-8798	Jackpot Multiplier Flshr #89
42	14-7982	A-16228	Wheel Motor

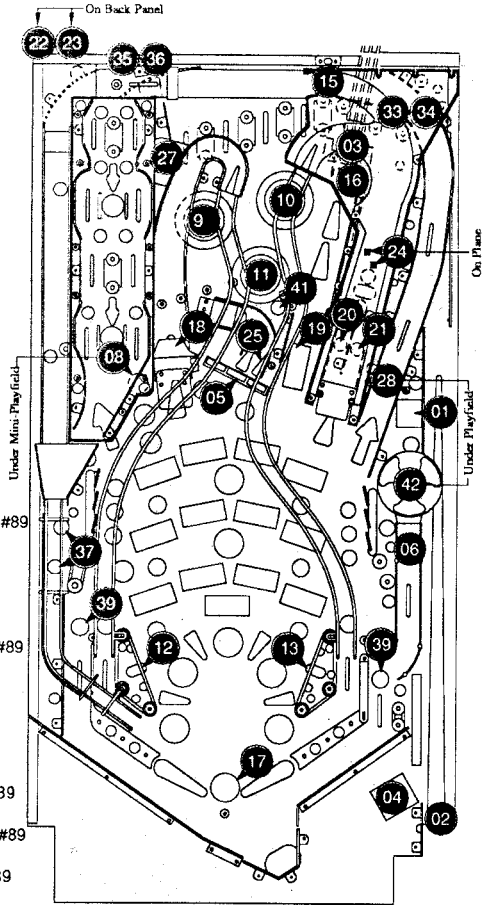

## General Illumination

01	24-6549	-----	*Top Playfield #44
02	24-6549	-----	*Bottom Playfield #44
03	24-8768	-----	*Insert Top #555
04	24-8768	-----	*Insert Bottom #555
05	24-6549	-----	*Return Lane/Coin #44

## Flippers

29-30	FL-11629	A-15205-R-2	*Lower Right Flipper
31-32	FL-11629	A-15205-L-2	*Lower Left Flipper
33	FL-11753-1	A-16301	Diverter Power
34	FL-11753-1	A-16301	Diverter Hold
35	A-15943	A-16656	Top Lockup Power
36	A-15943	A-16656	Top Lockup Hold

\* Not Shown

# LAMP MATRIX

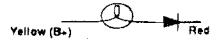

Column \ Row	1 Yellow-Brown J137-1 Q86	2 Yellow-Red J137-2 Q87	3 Yellow-Orange J137-3 Q86	4 Yellow-Black J137-4 Q85	5 Yellow-Green J137-5 Q84	6 Yellow-Blue J137-6 Q83	7 Yellow-Violet J137-7 Q82	8 Yellow-Gray J137-8 Q81
1 Red-Brown J133-1 Q90	Mode Start 11	Tank Chase 21	Left Ramp Arrow 31	Mine Cart 41	Choose Wisely 51	(I)ndy 61	Mini Top Left 71	Mini Middle Bottom Left 81
2 Red-Black J133-2 Q89	Hand of Fate 12	Adventure Light 22	Castle Grunewald 32	Ark Jackpot 42	Right Plane Top 52	(I)ndy 62	Mini Top Right 72	Mini Middle Bottom Right 82
3 Red-Orange J133-4 Q88	Eject Extra Ball 13	Adventure Light 23	Left Plane Top 33	Raven Bar 43	Rope Bridge 53	(I)ndy 63	Mini Middle Top Left 73	Mini Bottom Left 83
4 Red-Yellow J133-5 Q87	Adventure Light 14	Adventure Light 24	Monkey Brains 34	Right Plane Middle 44	Adventure Light 54	(I)ndy 64	Mini Middle Top Right 74	Mini Bottom Right 84
5 Red-Green J133-6 Q86	Adventure Light 15	Steal The Stones 25	Left Plane Middle 35	Bonus 6X 45	Adventure Light 55	Willie 65	Mini Top Arrow 75	Mini Bottom Arrow 85
6 Red-Blue J133-7 Q85	Adventure Light 16	Grail Jackpot 26	Salah 36	Right Plane Bottom 46	Adventure Light 56	Bonus 2X 66	Marion 76	Totem Top Arrow 86
7 Red-Violet J133-8 Q84	Shoot Again 17	Streets Of Cairo 27	Bonus 4X 37	Wall Of Souls 47	The 3 Challenges 57	Shorty 67	Bonus 8X 77	Center Lock 87
8 Red-Gray J133-9 Q83	Get The Idol 18	Stones Jackpot 28	Left Plane Bottom 38	Left Loop 48	Right Loop 58	Right Ramp Arrow 68	Dr. Jones 78	Start Button 88

# LAMP LOCATION

Item	Bulb No.	Lamp Assy No.	Description
11	24-8768	A-16716-2	Mode Start #555
12	24-8768	A-16716-2	Hand of Fate #555
13	24-8768	A-16716-2	Eject Extra Ball #555
14	24-8768	A-16716-2	Ad(v)enture Light #555
15	24-8768	A-16716-2	A(d)venture Light #555
16	24-8768	A-16716-2	(A)dventure Light #555
17	24-8768	A-16716-2	Shoot Again #555
18	24-8768	A-16716-2	Get the Idol #555
21	24-8768	A-16716-2	Tank Chase #555
22	24-8768	A-16716-2	Adven(t)ure Light #555
23	24-8768	A-16716-2	Adv(e)nture Light #555
24	24-8768	A-16716-2	Adve(n)ture Light #555
25	24-8768	A-16716-2	Steal the Stones #555
26	24-8768	A-16716-2	Grail Jackpot #555
27	24-8768	A-16716-2	Street of Cairo #555
28	24-8768	A-16716-2	Stones Jackpot #555
31	24-8768	A-16716-2	Left Ramp Arrow #555
32	24-8768	A-16716-2	Castle Grunewald #555
33	24-8768	A-16716-2	Left Plane Top #555
34	24-8768	A-16716-2	Monkey Brains #555
35	24-8768	A-16716-2	Left Plane Middle #555
36	24-8768	A-16716-2	Sallah #555
37	24-8768	A-16716-2	Bonus 4X #555
38	24-8768	A-16716-2	Left Plane Bottom #555
41	24-8768	A-16716-2	Mine Cart #555
42	24-8768	A-16716-2	Ark Jackpot #555
43	24-8768	A-16716-2	Raven Bar #555
44	24-8768	A-16716-2	Right Plane Middle #555
45	24-8768	A-16716-2	Bonus 6X #555
46	24-8768	A-16716-2	Right Plane Bottom #555
47	24-8768	A-16716-2	Well of Souls #555
48	24-6549	A-11754	Left Loop #44
51	24-8768	A-16716-2	Choose Wisely #555
52	24-8768	A-16716-2	Right Plane Top #555
53	24-8768	A-16716-2	Rope Bridge #555
54	24-8768	A-16716-2	Advent(ure) Light #555
55	24-8768	A-16716-2	Adventu(r)e Light #555
56	24-8768	A-16716-2	Adventur(e) Light #555
57	24-8768	A-16716-2	The 3 Challenges #555
58	24-8768	B-15648	Right Loop #555
61	24-8768	A-16739	(I)-N-D-Y #555
62	24-8768	A-16739	I-(N)-D-Y #555
63	24-8768	A-16739	I-N-(D)-Y #555
64	24-8768	A-16739	I-N-D-(Y) #555
65	24-8768	A-16823	Willie #555
66	24-8768	A-16823	Bonus 2X #555
67	24-8768	A-16823	Shorty #555
68	24-6549	A-11754	Right Ramp Arrow #44
71	24-8768	A-16746	Mini Top Left #555
72	24-8768	A-16746	Mini Top Right #555
73	24-8768	A-16746	Mini Mid. Top Left #555
74	24-8768	A-16746	Mini Mid. Top Right #555
75	24-8768	A-16746	Mini Top Arrow #555
76	24-8768	A-16823	Marion #555
77	24-8768	A-16823	Bonus 8X #555
78	24-8768	A-16823	Dr. Jones #555

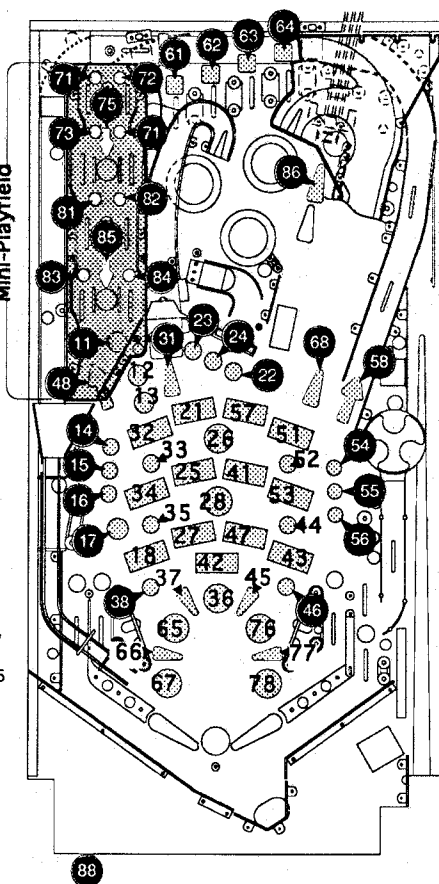

Item	Bulb No.	Lamp Assy No.	Description
81	24-8768	A-16747	Mini Mid. Bot. Left #555
82	24-8768	A-16747	Mini Mid. Bot. Right #555
83	24-8768	A-16747	Mini Bottom Left #555
84	24-8768	A-16747	Mini Bottom Right #555
85	24-8768	A-16747	Mini Bottom Arrow #555
86	24-6549	A-11754	Totem Top Arrow #44
87	24-6549	A-11754	Center Lock #44
88	-----	20-9663-11	Start Button

# SWITCH MATRIX

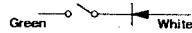

Dedicated Grounded Switches	Column	1 Green-Brown J207-1 U20-18	2 Green-Red J207-2 U20-17	3 Green-Orange J207-3 U20-16	4 Green-Yellow J207-4 U20-15	5 Green-Black J207-5 U20-14	6 Green-Blue J207-6 U20-13	7 Green-Violet J207-7 U20-12	8 Green-Gray J207-9 U20-11	9 Violet-White C11 J5-4	Flipper Grounded Switches
	Row	10 White-Brown J209-1 U18-11	11 White-Red J209-2 U18-9	12 White-Orange J209-3 U18-5	13 White-Yellow J209-4 U18-7	14 White-Green J209-5 U19-11	15 White-Blue J209-7 U19-9	16 White-Violet J209-8 U19-5	17 White-Gray J209-9 U19-7		
Orange-Brown J205-1 Left Coin Chute D1	11	21	31	41	51	61	71	81	91	Black-Green J906-1 Lower Right E.O.S. F1	
Orange-Red J205-2 Center Coin Chute D2	12	22	32	42	52	62	72	82	92	Blue-Violet J905-1 Lower Right Opto F2	
Orange-Black J205-3 Right Coin Chute D3	13	23	33	43	53	63	73	83	93	Black-Blue J906-3 Lower Left E.O.S. F3	
Orange-Yellow J205-4 4th Coin Chute D4	14	24	34	44	54	64	74	84	94	Blue-Gray J905-2 Lower Left Opto F4	
Orange-Green J205-6 Normal Function Service Credits D5	15	25	35	45	55	65	75	85	95	Black-Violet J906-4 Center Drop Bank Left F5	
Orange-Blue J205-7 Normal Function Volume Down D6	16	26	36	46	56	66	76	86		Black-Yellow J905-3 Center Drop Bank Middle F6	
Orange-Violet J205-8 Normal Function Volume Up D7	17	27	37	47	57	67	77	87		Black-Gray J906-5 Center Drop Bank Right F7	
Orange-Gray J205-9 Normal Function Begin Test D8	18	28	38	48	58	68	78	88		Black-Blue J905-5 Left Ramp Made F8	

\*Note: Used as switches other than flipper switches in this game.

# SWITCH LOCATIONS

Item	Switch No.	Where Used
F1	SW-1A-194	Lwr Rt. Flipper EOS
F2	A-16384-1	Lwr Rt. Flipper Cab.
F3	SW-1A-194	Lwr Lt. Flipper EOS
F4	A-16384-1	Lwr Lt. Flipper Cab.
F5	A-13609	Center Drop Bank Left
F6	A-13609	Center Drop Bank Mid.
F7	A-13609	Center Drop Bank Right
F8	5647-12693-21	Left Ramp Made
F9	5647-12693-31	Single Drop Target
10	20-9663-12	Buy-in Button
11	20-9663-11	Start Button
12	A-6502-A	Plumb Bob Tilt
13	A-12688	Left Outlane
14	A-12688	Left Return Lane
15	A-12688	Right Return Lane
16	A-12688-1	Right Outlane Top
17	SW-1A-117	Slam Tilt
18	5643-09288-00	Coin Door Closed
19	22	Not Used
20	5643-09288-00	†Always Closed
21	A-12688	(l)ndy Lane
22	A-12688	(r)ndy Lane
23	A-12688	In(d)ly Lane
24	A-12688	Ind(y) Lane
25	5647-12133-11	Left Exit
26	5647-12693-25	Exit Idol
27	SW-1A-114 (kick)	Left Slingshot
28	SW-1A-120 (score*)	
29	5647-12133-12	Gun Trigger
30	SW-11A-37	Left Jet Bumper
31	SW-11A-37	Right Jet Bumper
32	SW-11A-37	Bottom Jet Bumper
33	A-16816-4	Center Standup Target
34	A-16908 (LED)	Left Ramp Enter
35	A-16909 (trans.)	
36	A-14231 (LED)	Right Ramp Enter
37	A-14232 (trans.)	
38	A-14231 (LED)	Top Idol Enter
39	A-14232 (trans.)	
40	A-14231 (LED)	Right Popper
41	A-14232 (trans.)	
42	A-14231 (LED)	Center Enter
43	A-14232 (trans.)	
44	5647-12693-56	Top Post
45	A-14231 (LED)	Subway Lockup
46	A-14232 (trans.)	
47	SW-1A-114 (kick)	Right Slingshot
48	SW-1A-120 (score*)	
49	A-14691-4	Advent(ure) Target
50	A-14691-4	Advent(ure) Target
51	A-14691-4	Adventur(e) Target
52	A-12688	Left Loop Top
53	A-12688	Left Loop Bottom
54	A-12688	Right Loop Top
55	A-12688	Right Loop Bottom
56	A-12688	Right Outlane Bottom
57	A-14691-4	(A)dventure Target
58	A-14691-4	A(d)venture Target
59	A-14691-4	Ad(v)enture Target
60	A-16418	Captive Ball Back
61	A-12688	Mini Top Left
62	A-12688	Mini Mid. Top Left
63	A-12688	Mini Mid. Bottom Left
64	A-12688	Mini Bottom Left
65	A-12688	Mini Bottom Right
66	A-14231 (LED)	Captive Ball Front
67	A-14232 (trans.)	
68	A-16908 (LED)	Mini Top Hole
69	A-16909 (trans.)	
70	A-16908 (LED)	Mini Bottom Hole
71	A-16909 (trans.)	
72	5647-12693-21	Right Ramp Made
73	A-12688-1	Mini Top Right
74	A-12688-1	Mini Mid. Top Right
75	A-12688-1	Mini Mid. Bot. Right
76	A-12688-1	Mini Bottom Right
77	A-16927 (LED)	Trough 6
78	A-16926 (trans.)	
79	A-16927 (LED)	Trough 5
80	A-16926 (trans.)	
81	A-16927 (LED)	Trough 4
82	A-16926 (trans.)	
83	A-16927 (LED)	Trough 3
84	A-16926 (trans.)	

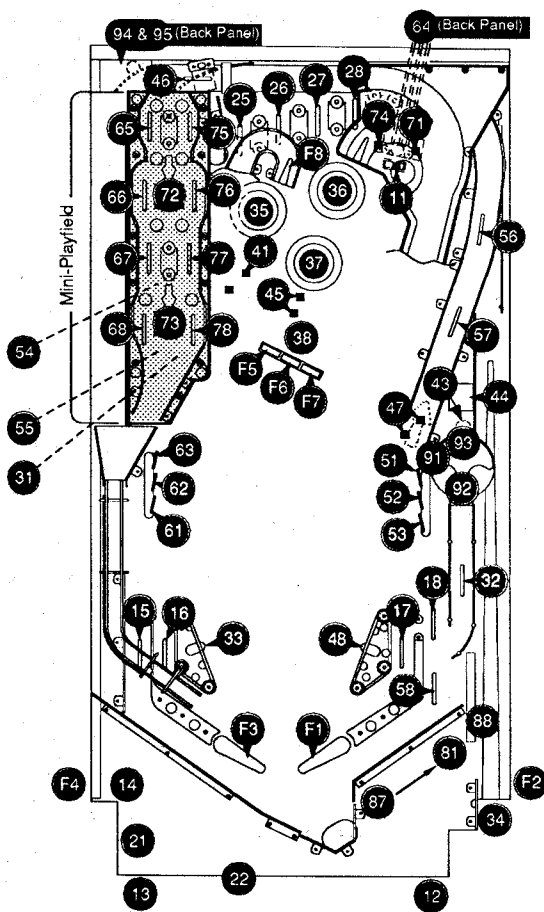

Item	Switch No.	Where Used
85	A-16927 (LED)	Trough 2
86	A-16926 (trans.)	
87	A-16927 (LED)	Trough 1
88	A-16926 (trans.)	
89	A-16927 (LED)	Trough Top
90	A-16926 (trans.)	
91	A-12688	Shooter
92	A-14231 (LED)	Wheel Position 1
93	A-14232 (trans.)	
94	A-14231 (LED)	Wheel Position 2
95	A-14232 (trans.)	
96	A-14231 (LED)	Wheel Position 3
97	A-14232 (trans.)	
98	A-16657	Mini Plfd Right Limit
99	A-16657	Mini Plfd Left Limit

† Not Shown

\* The Score slingshot switches have diodes across them.

# MAIN MENU OPERATION

This game operates on a Menu System. The Main Menu allows you to choose from several main categories, which in turn lead to other menus to choose from. To enter the Menu System, open the coin door and press the Begin Test button. The displays show the Game I.D. Mode. Press the Enter button and the Main Menu appears. To cycle through the Main Menu, (or any other menu), selections press either the Up or Down button. Activate any selection by pressing the Enter button when the desired selection appears in the display. Return to the Attract Mode or a previous menu selection, by pressing the Escape button. Press the Start button for HELP at any time.

## MAIN MENU

### B. Bookkeeping Menu

- B.1 Main Audits
- B.2 Earning Audits
- B.3 Standard Audits
- B.4 Feature Audits
- B.5 Histograms
- B.6 Time-stamps

#### Press Escape

To move out of a menu selection.

#### Press Enter

To get into a menu selection.

#### Press Up

Increases sequence; (ex. A.1, A.2, A.3, A.4).

#### Press Down

Decreases sequence; (ex. A.4, A.3, A.2, A.1).

### P. Printouts Menu

- P.1 Earnings Data
- P.2 Main Audits
- P.3 Standard Audits
- P.4 Feature Audits
- P.5 Score Histograms
- P.6 Time Histograms
- P.7 Time-Stamp
- P.8 All Data

Use Up or Down to cycle through the selections in a menu.

### T. Test Menu

- T.1 Switch Edges Test
- T.2 Switch Levels Test
- T.3 Single Switches Test
- T.4 Solenoid Test
- T.5 Flasher Test
- T.6 General Illumination Test
- T.7 Sound and Music Test
- T.8 Single Lamps Test
- T.9 All Lamps Test
- T.10 Lamp & Flasher Test
- T.11 Display Test
- T.12 Flipper Coil Test
- T.13 Ordered Lamps Test
- T.14 Idol Lock Test
- T.15 Mini Playfield Test

Use Escape and Enter to move into and out of the selected menu.

### U. Utilities Menu

- U.1 Clear Audits
- U.2 Clear Coins
- U.3 Reset H.S.T.D.
- U.4 Set Time & Date
- U.5 Custom Message
- U.6 Set Game I.D.
- U.7 Factory Adjustments
- U.8 Factory Resets
- U.9 Presets
- U.10 Clear Credits
- U.11 Auto Burn-in

### A. Adjustments Menu

- A.1 Standard Adjustments
- A.2 Feature Adjustments
- A.3 Pricing Adjustments
- A.4 H.S.T.D. Adjustments
- A.5 Printer Adjustments

## FUSE LIST

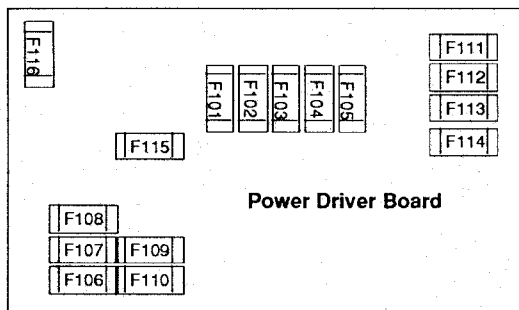
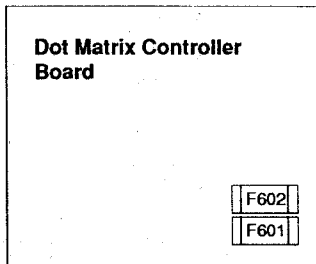
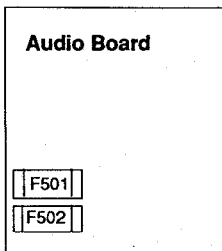
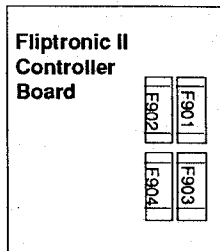

**Audio Board**

F501 -25V Circuit, 3A, S.B.  
 F502 +25V Circuit, 3A, S.B.

**Dot Matrix Controller Board**

F601 +62V Circuit, 3/8A, S.B.  
 F602 -113V and -125V Circuits, 3/8A, S.B.

**Power Driver Board**

F101 Left Flipper, 3A, S.B. Not Used  
 F102 Right Flipper, 3A, S.B. Not Used  
 F103 Solenoid #25-#28, 3A, S.B.  
 F104 Solenoid #9-#16, 3A, S.B.  
 F105 Solenoid #1-#8, 3A, S.B.  
 F106 G.I. #5 Wht-Vio, 5A, S.B.  
 F107 G.I. #4 Wht-Grn, 5A, S.B.  
 F108 G.I. #3 Wht-Yel, 5A, S.B.  
 F109 G.I. #2 Wht-Org, 5A, S.B.  
 F110 G.I. #1 Wht-Brn, 5A, S.B.  
 F111 Flasher Secondary, 5A, S.B.  
 F112 Solenoid Secondary, 7A, S.B.  
 F113 +5V Logic, 5A, S.B.  
 F114 +18V Lamp Matrix, 8A, N.B.  
 F115 +12V Switch Matrix, 3/4A, S.B.  
 F116 +12V Secondary, 3A, S.B.

**Fliptronic II Controller Board**

F901 Upper Right Flipper, 3A, S.B.  
 F902 Upper Left Flipper, 3A, S.B.  
 F903 Lower Right Flipper, 3A, S.B.  
 F904 Lower Left Flipper, 3A, S.B.

**Line Filter**

Domestic Game 8A, N.B.  
 Foreign Game 5A, S.B.

## WARNINGS & NOTICES

### WARNING

**FOR SAFETY AND RELIABILITY**, substitute parts and equipment modifications are not recommended. Use of Non-WILLIAMS parts or modifications of game circuitry, may adversely affect game play, or may cause injuries.

**SUBSTITUTE PART OR EQUIPMENT MODIFICATIONS** may void FCC Type Acceptance.

**BECAUSE THIS GAME IS PROTECTED** by Federal copyright, trademark, and patent laws, unauthorized game conversions may be illegal under Federal law.

**THIS 'CONVERSION' PRINCIPLE ALSO APPLIES** to unauthorized facsimiles of WILLIAMS equipment, logos, designs, publications, assemblies, and games (or game feature not deemed to be public domain), whether manufactured with WILLIAMS components or not.

### NOTICE

WILLIAMS, Lane-change and Multi-ball are trademarks of WILLIAMS ELECTRONICS GAMES, INC. Entire contents of this manual © 1993 WILLIAMS ELECTRONICS GAMES, INC.

### WARNING

**Note:** This equipment has been tested and found to comply with the limits for a Class A digital device, pursuant to Part 15 of the FCC Rules. These limits are designed to provide reasonable protection against harmful interference when the equipment is operated in a commercial environment. This equipment generated, uses, and can radiate radio frequency energy and if not installed and used in accordance with the instruction manual, may cause harmful interference to radio communications. Operation of this equipment in a residential area is likely to cause harmful interference in which case the user will be required to correct the interference at his own expense.

### RF Interference Notice

**CABLE HARNESS PLACEMENTS** and ground strap routing on this game have been designed to keep RF radiation and conduction within levels accepted by the FCC Rules.

**TO MAINTAIN THESE LEVELS**, reposition harnesses and reconnect ground straps to their original placements, if they become disconnected during maintenance.

**FCC STICKER.** Check the back of your game to verify that an FCC-certification sticker was attached to your game at the factory. All games that leave the WILLIAMS plant have been tested and found to comply with FCC Rules. Because the sticker is proof of this fact, legal repercussions to the owner and distributor may result, if the sticker is missing. If you receive a game, manufactured after December 1982, that has no FCC sticker, call WILLIAMS for advice or write us a note on your Game Registration Card. Be sure that the card bears your game's serial number.

Theme Music to:  
"Raiders of the Lost Ark,"  
©1981 Bartha Music  
"Indiana Jones and the Temple of Doom"  
© 1984 Bartha Music  
"Indiana Jones and the Last Crusade"  
©1989 Bartha Music  
(Composer: John Williams)  
Used by Permission - All Rights Reserved



### CAUTION

**Transport this game ONLY with hinged backbox DOWN!**

**FOR SERVICE... CALL your authorized WILLIAMS Distributor.**